

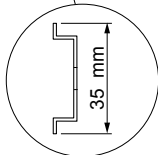

00162468611010

Altistart ATS 01N2●●LU/QN/RT

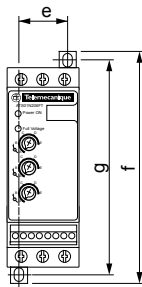
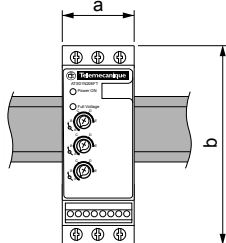
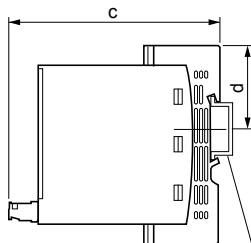
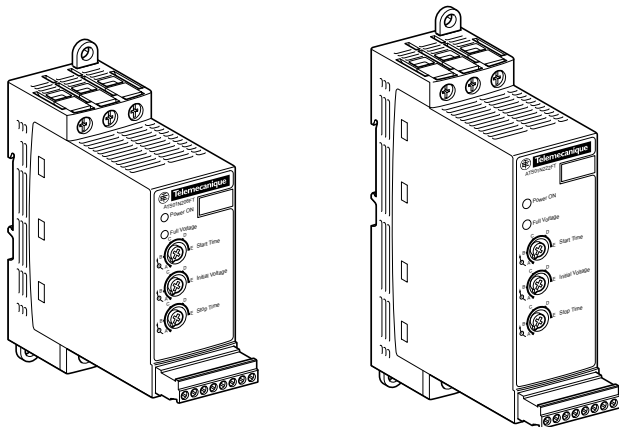

Schneider
Electric

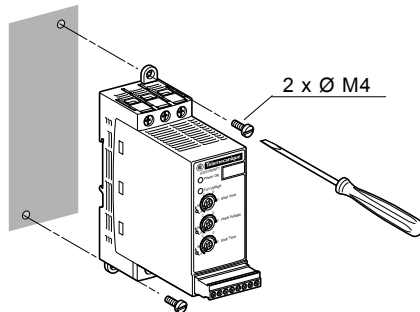
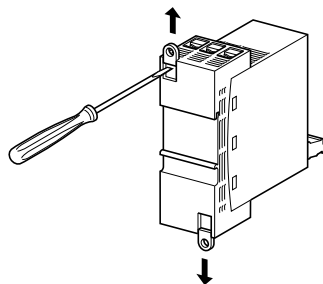

	a	b	c	d	e	f	g
	mm	mm	mm	mm	mm	mm	mm
ATS 01N206●●	45	124	131	53	30	145	132
ATS 01N209●●							
ATS 01N212●●							
ATS 01N222●●	45	154	131	72	30	175	162
ATS 01N232●●							



W9 1624686 01 11 A01
11 - 2003

				
	[mm ²]	AWG	Nm	lb/in
1/L1, 2/T1, 3/L2, 4/T2, 5/L3, 6/T3	10	8	1,9...2,5	17...22
R1A, R1C, COM, LI+, LI1, LI2, LO1, BOOST	2,5	14	0,5	4,5

	UL  CLASS J
ATS 01N206●●	20 A
ATS 01N209●●	30 A
ATS 01N212●●	35 A
ATS 01N222●●	80 A
ATS 01N232●●	100 A

	U1	
ATS 01N2●●LU	200 - 240 V	50 / 60 Hz
ATS 01N2●●QN	380 - 415 V	50 / 60 Hz
ATS 01N2●●RT	440 - 480 V	50 / 60 Hz

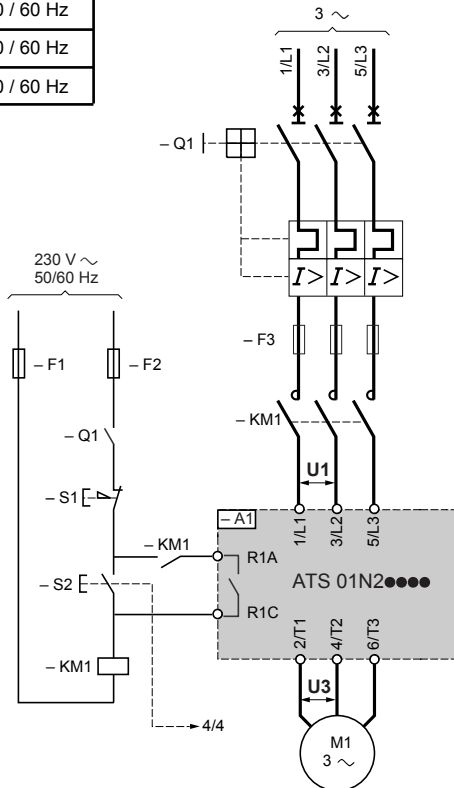
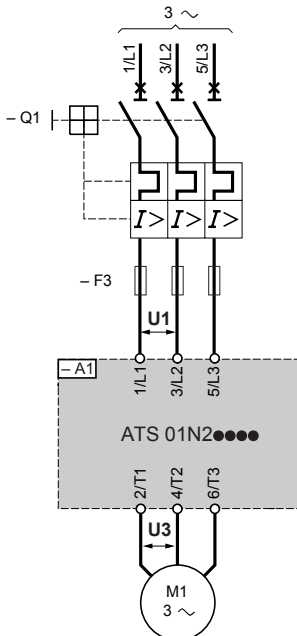

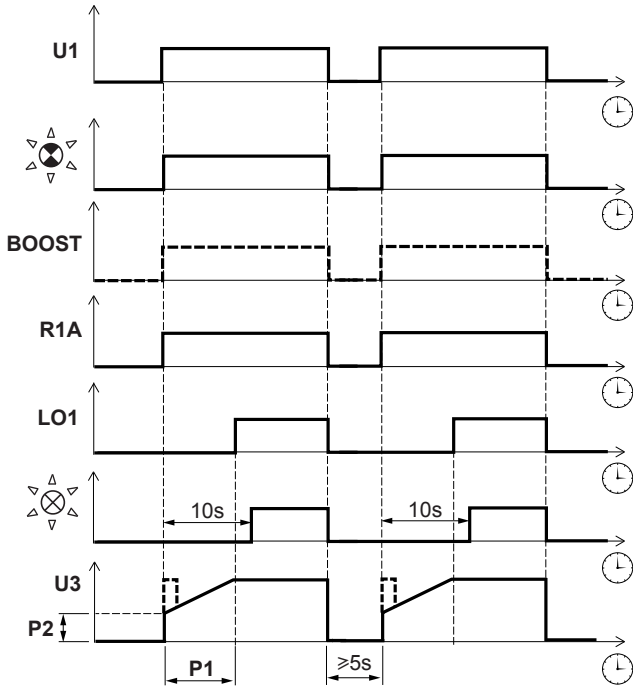
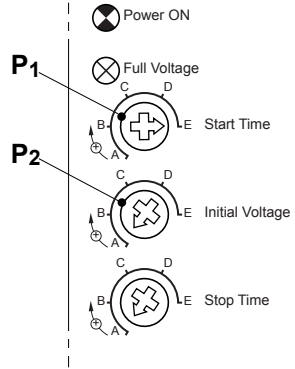
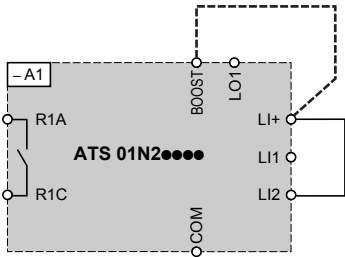

Power ON

